

# Field Guide

## F3 Compact Mine Detector

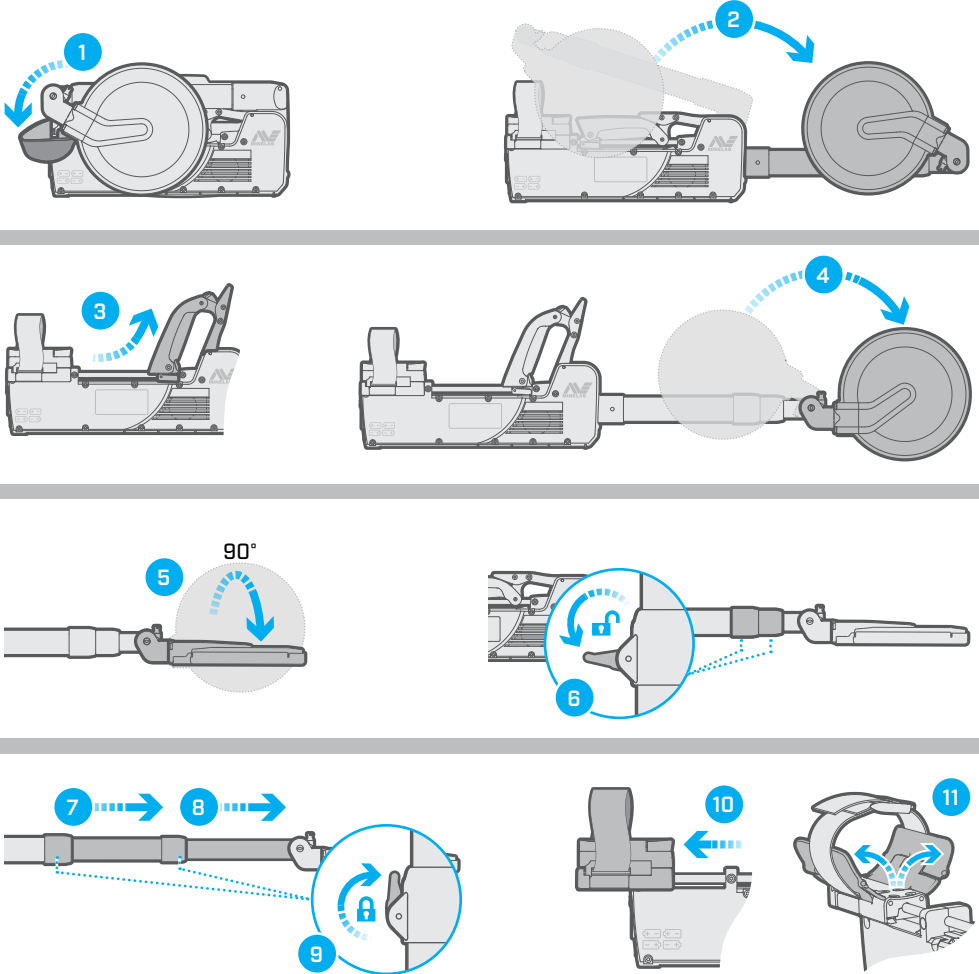

### Unfolding Procedure



### Pack Up

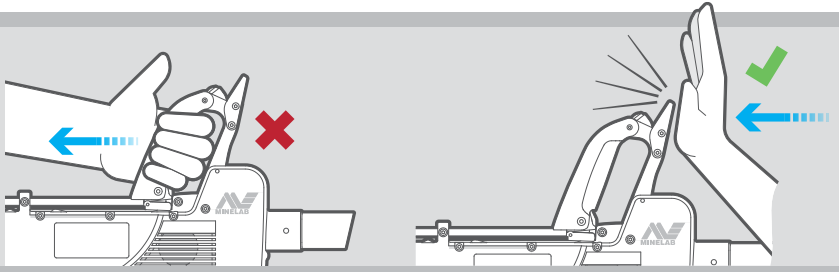

### 1. Switch On

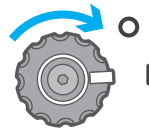
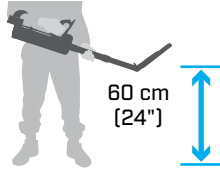
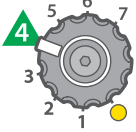

### 2. Ground Balance

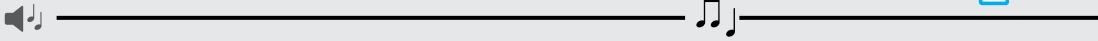
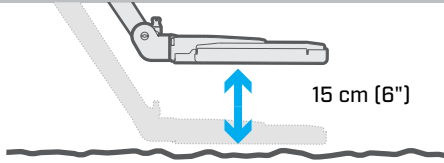

### 3. Test Piece

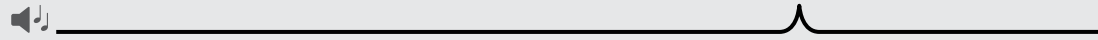
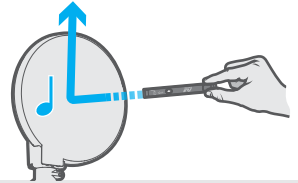
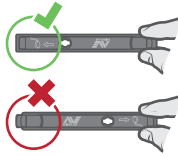
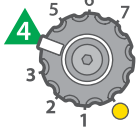

### 4. Audio Reset



### 5. Noise Cancel

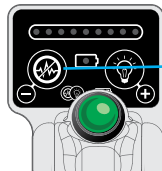
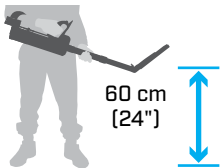
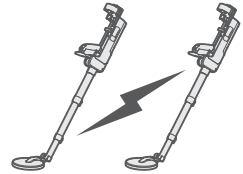
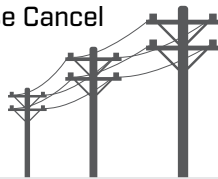

Hold for 2 seconds



### Volume Control

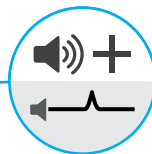
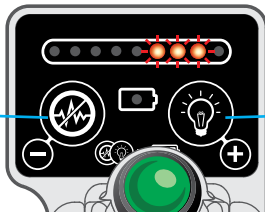
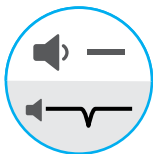

Default Setting

